

KLT-ENT-IMX214 V1.0

13MP Sony IMX214 MIPI-Schnittstelle Autofokus Kameramodul

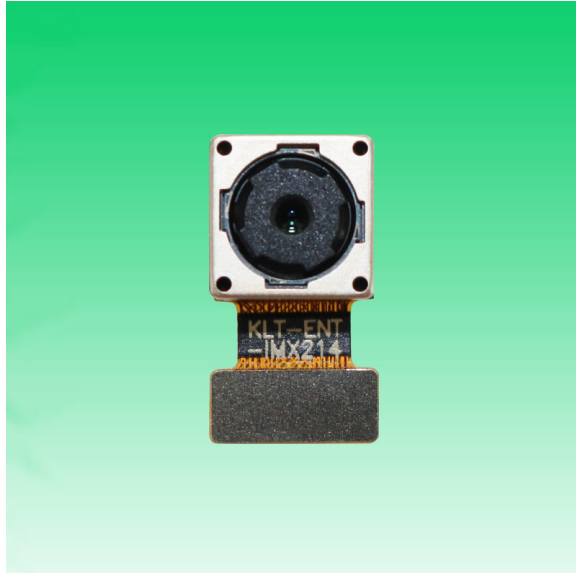

Vorderansicht

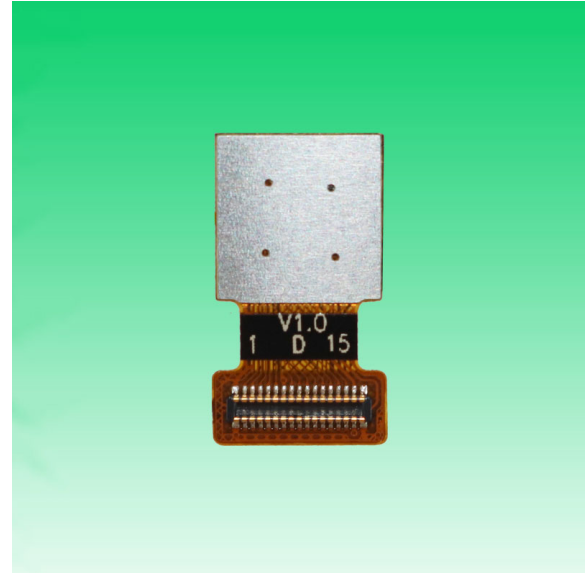

Rückansicht

Spezifikationen

Kameramodul Nr.	KLT-ENT-IMX214 V1.0
Auflösung	13MP
Bildsensor	IMX214
Sensorart	1/3.06"
Pixel Größe	1.12 um x 1.12 um
EFL	3.85 mm
F.NO	2.20
Pixel	4224 x 3136
Betrachtungswinkel	74.4°(DFOV) 62.7°(HFOV) 48.7°(VFOV)
Linsenabmessungen	8.50 x 8.50 x 5.37 mm
Modulgröße	16.07 x 9.00 mm
Modultyp	Autofokus
Schnittstelle	MIPI
Autofokus-VCM-Treiber-IC	FP5510
Linsenmodell	KLT-LENS-50013A1
Linsentyp	650 nm IR-Schnitt
Betriebstemperatur	-20°C to +70°C
Gegenstecker	BM20B(0.8)-30DS-0.4V(51)

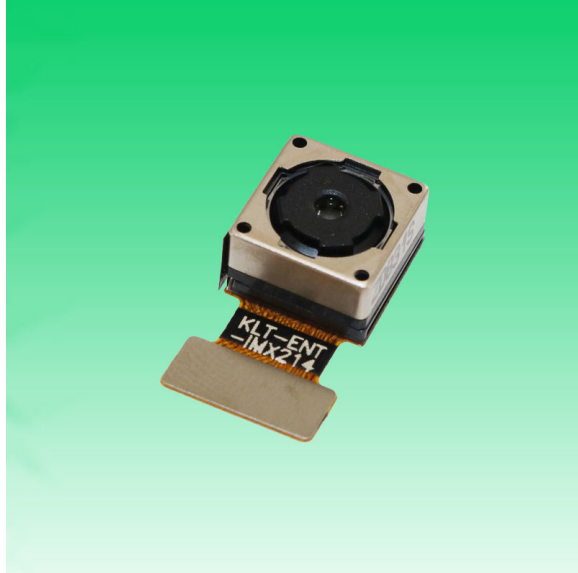
KLT-ENT-IMX214 V1.0**13MP Sony IMX214 MIPI-Schnittstelle Autofokus Kameramodul**

Ansicht von oben



Seitenansicht



Untersicht



Gegenstecker



your BEST camera module partner

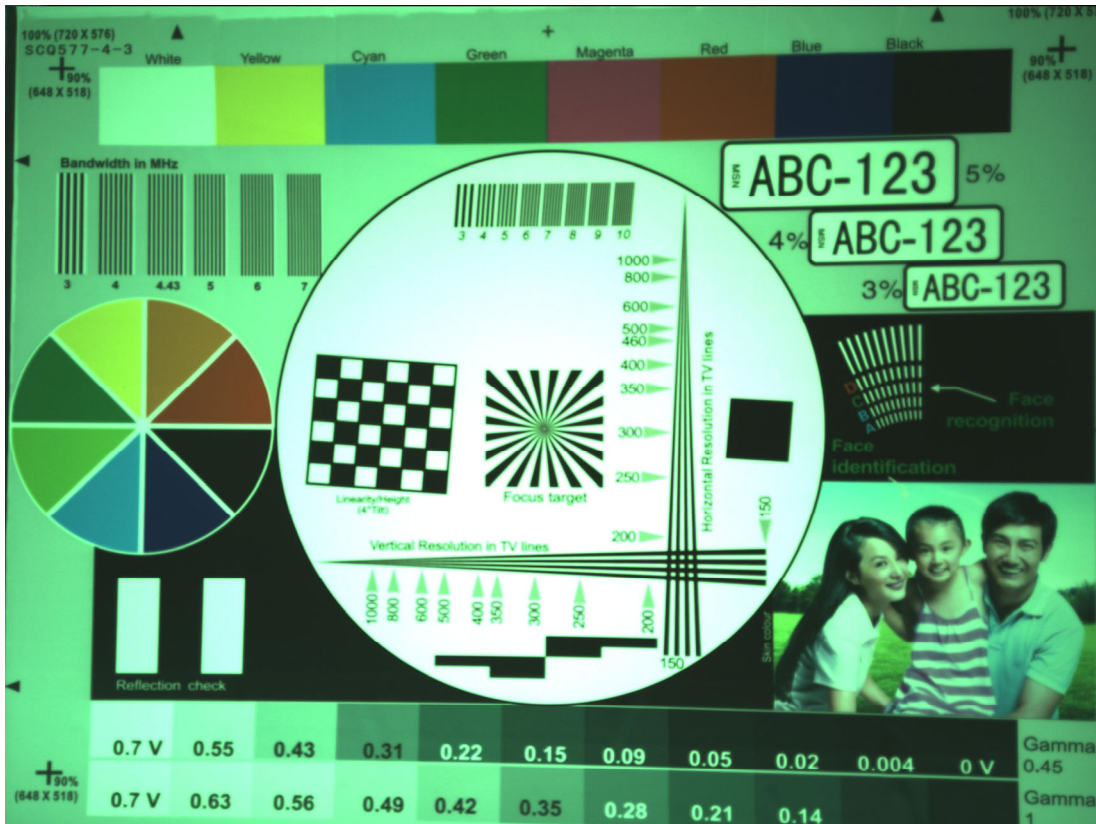

www.KaiLapTech.com sales@KaiLapTech.com Tel: (852) 6908 1256 Fax: (852) 3017 6778

All rights reserved @ Kai Lap Technologies Group Ltd. Specifications subject to change without notice.

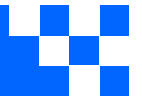

your BEST camera module partner

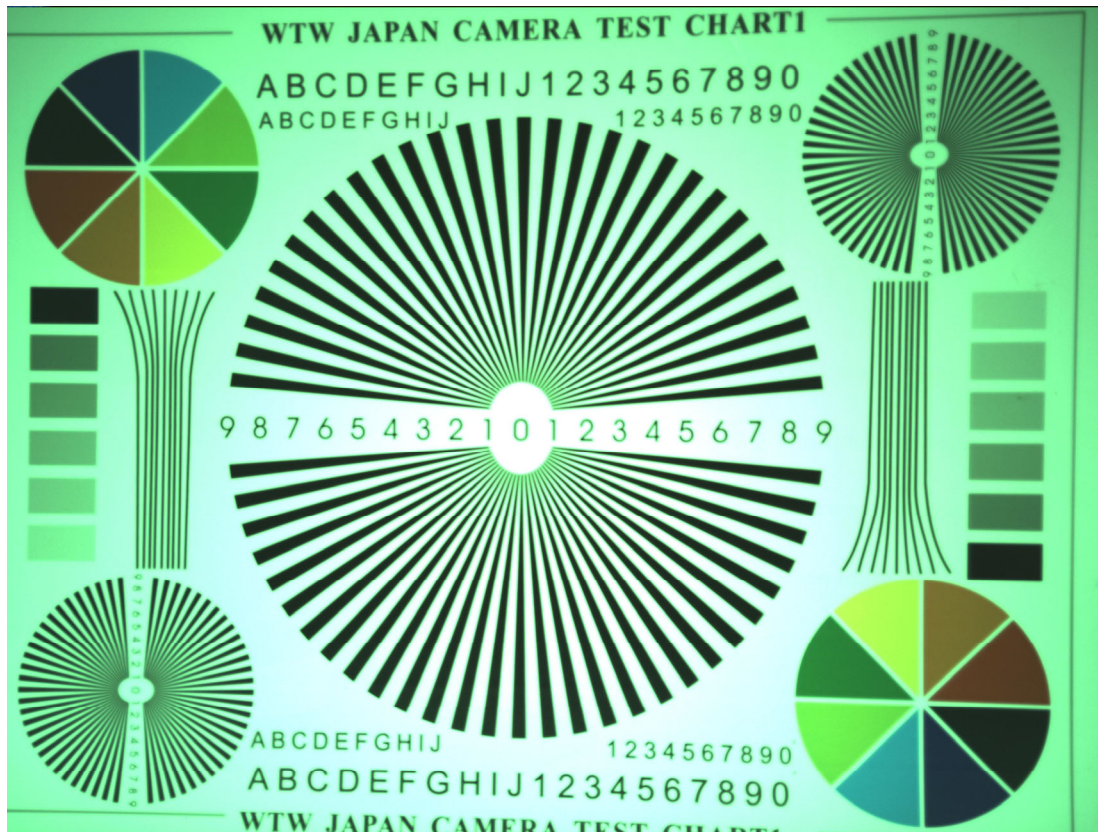

RoHS

1	MDN1
2	MDP1
3	DGND
4	MDN3
5	MDP3
6	DGND
7	MDN0
8	MDP0
9	DGND
10	MDN2
11	MDP2
12	DGND
13	MCN
14	MCP
15	AGND
16	AF_VDD 2.8V
17	AVDD 2.8V
18	DVDD 1.05V
19	DOVDD 1.8V
20	NC
21	XCLK
22	NC
23	NC
24	SCL
25	SDA
26	RESET
27	NC
28	NC
29	NC
30	NC

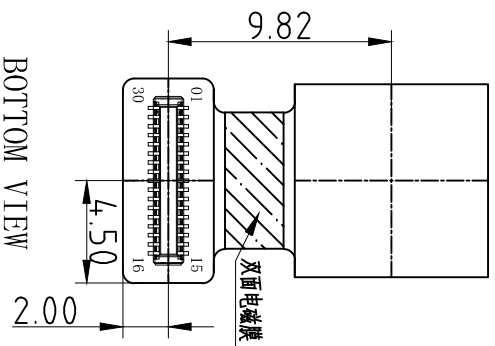
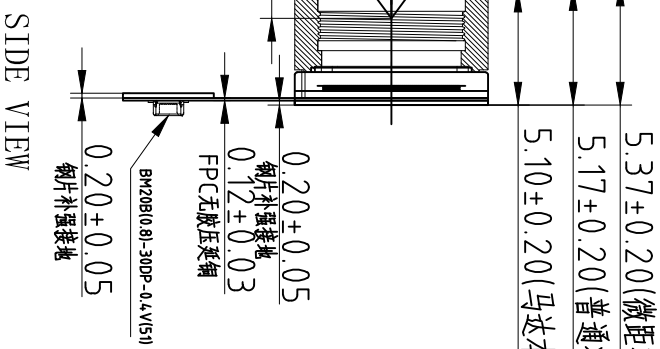
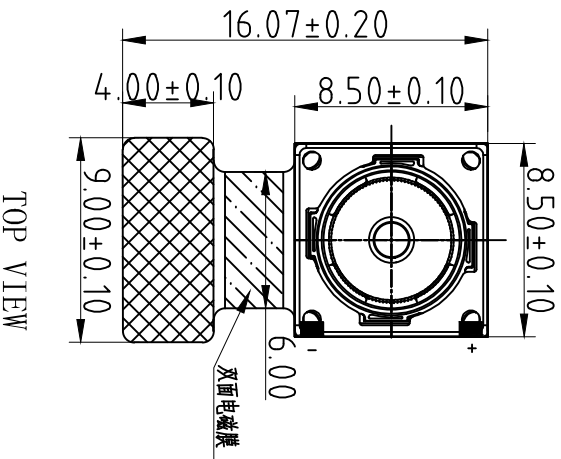
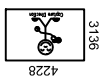

NOTE:
 1.The device slave address:0x20(w);0x21(r)
 2.Driver IC:FP5510

佳立数码 (深圳) 有限公司

Parameters:

1、Sensor specification:

Image Sensor: IMX214
 Pixel: 1.12umx1.12um
 Lens Type: 1/3.06
 Important Voltage Description: DVDD1.05V
 (External power supply);

2、Lens specification:

FOV: 74.4°
 F/NO.: 2.2±5%
 TV distortion: <1.5%
 Focal length: 3.81mm
 Composition: 5P

Designed By	Kevin	Model Name:	KLT-ENT-IMX214 V1.0		
Checked By	Aouly_Yan	Projection Type:	Third Angle	Unit:	mm
		Scale:	1:1	Sheet:	1 of 1
		Version:	1/0		

Version Mark	Information	Date
V1.0 PD	First Version	2018-12-05



Lens Model: KLT-LENS-50013A1

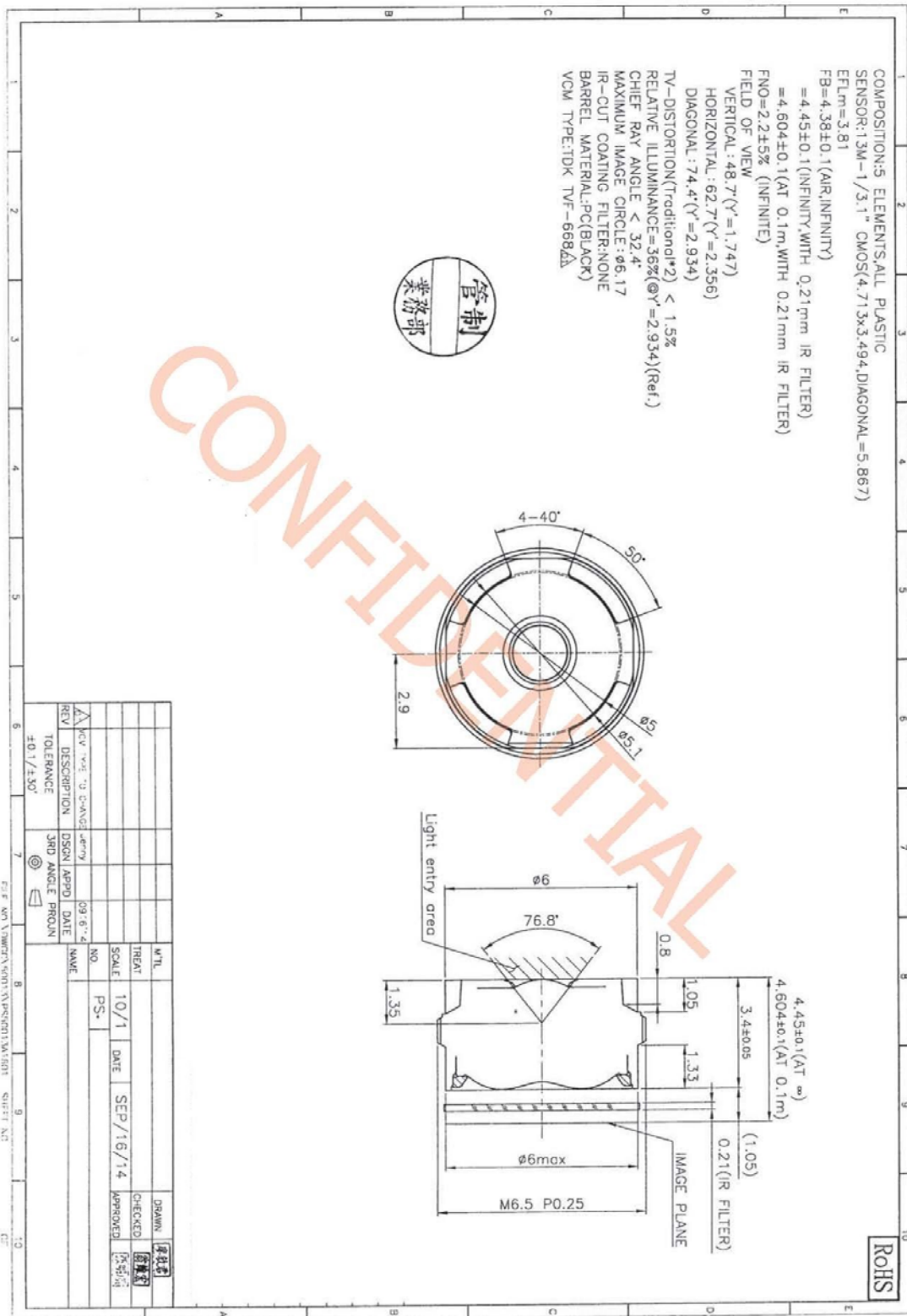

10-Bit DAC 120mA VCM Driver with I²C Interface

Description

The FP5510 is a single 10-bit DAC with 120mA output current voice coil motor (VCM) driver, with an I²C-compatible serial interface that operates at clock rates up to 400kHz. Its supply operates from 2.3V to 3.6V.

The FP5510 incorporates with a power-on reset circuit, power-down function. Power-on reset circuit ensure when supply power up, DAC output is to 0V until valid write bit value takes place. In power down mode, the supply current is about 1µA.

The FP5510 is designed for auto focus operation includes digital camera module, optical zoom camera phones and lens auto focus. The I²C address of FP5510 is 0x18h.

The FP5510 with WLCSP package which it is suitable for reduced-space mounting in mobile phone and other portable applications.

Pin Assignments

6-Ball WLCSP

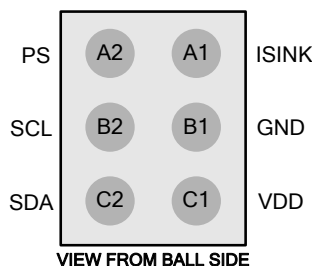

Figure 1. Pin Assignment of FP5510

Features

- Power Supply Voltage Rang: 2.3V to 3.6V
- VCM Driver for Auto-Focus
- 10-Bit Resolution Current Sinking of 120mA for VCM
- 2-Wire I²C Interface (1.8V Interface Compatible)
- Internal 4 Slope Control Mechanism
 1. Enhance Slope Control Mode
 2. One Step Mode
 3. Linear Slope Mode
 4. Two Step Slope Mode
- Power-Save Mode Current < 1µA
- Power On Reset (POR)
- Small Size: 0.7mm×1.1mm (6-Balls WLCSP)

Applications

- Digital Camera Module
- Cell Phone
- Lens Cover
- Web Camera

Ordering Information

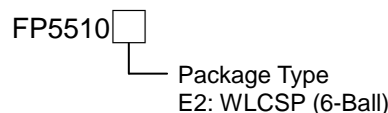

WLCSP-6 (0.7mm×1.1mm) Marking

Part Number	Product Code
FP5510E2	2

0.4mm Pitch, 0.6 and 0.8mm Height, Board-to-Board and Board-to-FPC Connectors

BM20 Series

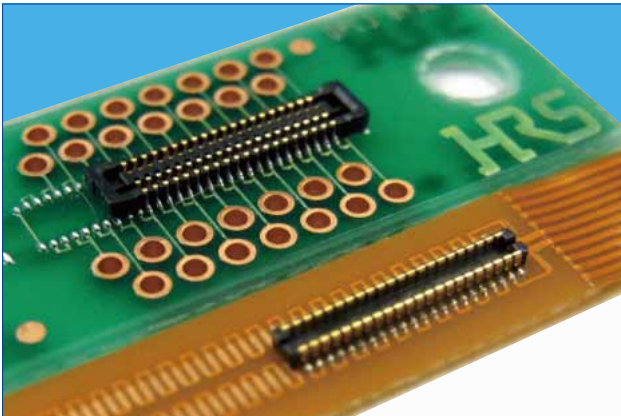

■ Features

1. High density mounting capability

A space saving design that keeps the connector compact, but still maintains an adequate vacuum area (no less than 0.7mm wide).
Depth DS : 2.3mm DP : 1.78mm

2. Reliable contact performance

Even though the mated height is low, the BM20 still leads it class in maximum effective mating lengths for each mating height.
<Effective Mating Length>
Height 0.8mm : 0.2mm
Height 0.6mm : 0.15mm
The addition of the two point contact system adds more reliability to the contacts.

3. No restrictions to PCB pattern design for the 0.8 mm height connector *1

This series utilizes a thin wall to insulate the bottom surface of the connector and maintains an effective mating length of 0.2mm. This removes any restriction for PCB pattern layout design under the connector.
Note *1: There are some restrictions for the 0.6 mm height style.

4. Enhanced mating operations

The structure uses guide ribs to ease the mating process and offers a self alignment range of up to 0.3mm. A clear tactile click is used as an indicator to the user that the mating process was completed.

5. Drop and shock resistant structure

Dimples were designed into the contacts to increase their retention force and to absorb the shock delivered from a drop or other impact.

6. Debris resisting design

When mated, the connector's design covers the contacts which help to keep dust and other debris away from the contacts. The SMT leads are kept very close to the connector housing which also helps to prevent shorts caused by debris on the exposed contacts

■ Receptacle

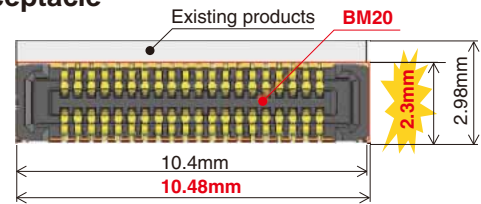

A 22.3% reduction in size!

Existing products	BM20
2.98 × 10.4 = About 31.0mm ²	2.3 × 10.48 = About 24.1mm ²

■ Header

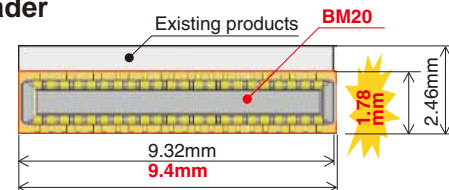

Board occupied area

A 27.1% reduction in size!

Existing products	BM20
2.46 × 9.32 = About 22.9mm ²	1.78 × 9.4 = About 16.7mm ²

Vacuum pick-up

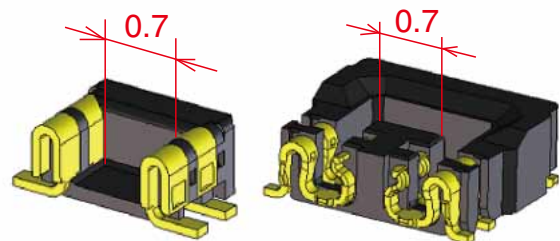

Mating diagram (cross section)

H=0.8

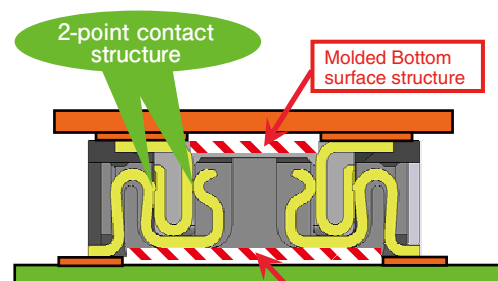

H=0.6

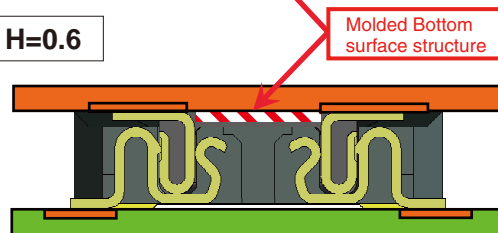

Product Specifications

Ratings	Rated Current	0.3A	Operating Temperature Range	- 35 ~ 85°C (Note 1)	Storage Temperature Range	- 10 ~ 60°C (Note 2)
	Rated Voltage	AC, DC 30V	Operating Humidity Range	20 ~ 80%	Storage Humidity Range	40 ~ 70% (Note 2)
Items	Specifications		Conditions			
1. Insulation Resistance	Minimum of 50MΩ		Measured with DC 100V			
2. Withstanding Voltage	No flashover or breakdown		Apply AC 100V for 1 minute			
3. Contact Resistance	Maximum of 100mΩ		Measured with AC 20 mV, 1 kHz and 1 mA			
4. Vibration Resistance	No electrical discontinuity of 1μs or greater		Frequency 10-55 Hz, half amplitude 0.75mm, 3 directions for 2 hours			
5. Humidity Resistance	Contact resistance Maximum of 100mΩ Insulation resistance Minimum of 25mΩ		Left at temperature 40±2°C, humidity 90 to 95%, 96 hours			
6. Temperature Cycles	Contact resistance Maximum of 100mΩ Insulation resistance Minimum of 50mΩ		(-55°C : 30 minutes → 5~35°C : 10 minutes → 85°C : 30 minutes → 5~35°C : 10 minutes) 5 cycles			
7. Durability	Contact Resistance: maximum of 100mΩ		10 mating cycles			
8. Soldering Heat Resistance	Should be no melting of resin parts that affects its performance		Reflow : according to the Recommended Solder Profile Hand solder : Soldering iron temperature 350°C, no more than 3 seconds.			

Note 1 : Includes temperature rise caused by current flow.

Note 2 : The term "storage" here refers to products stored for a long period prior to board mounting and use. The operating temperature and humidity range covers the non-energized condition of connectors after board mounting and the temporary storage conditions during transportation, etc.

Materials

Product	Component	Materials	Finish	UL Regulation
Receptacle	Insulator	LCP	Black	UL94V-0
Header	Contact	Phosphorous bronze	Gold plating	—

Product Number Structure

Refer to this page when determining product specifications by model types. Please place orders with part numbers listed in this catalog. The characteristics and specifications of the product described in this catalog are reference values. Please make sure to check the latest delivery specifications at the time of product use.

●Receptacle/Header

BM 20 # () - * DS - 0.4 V (51)**

① ② ③ ④ ⑤ ⑥ ⑦ ⑧ ⑨

① Series Name : BM	⑥ Connector Type DS : Double row receptacle DP : Double row header
② Series No. : 20	
③ Shape Symbols B : With reinforcing metal fitting	⑦ Contact Pitch : 0.4mm
④ Stack height : 0.6mm, 0.8mm	⑧ Terminal Shape V : Vertical SMT
⑤ No. of Contacts : Please refer to page 3 and after.	⑨ Packaging (51) : Embossed tape package (8,000 pieces per reel)

■ H=0.6mm receptacle

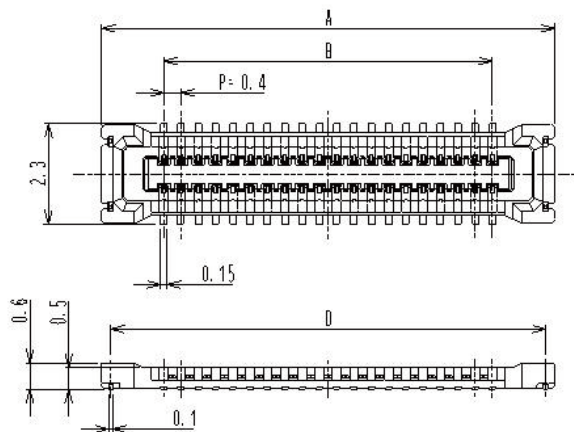
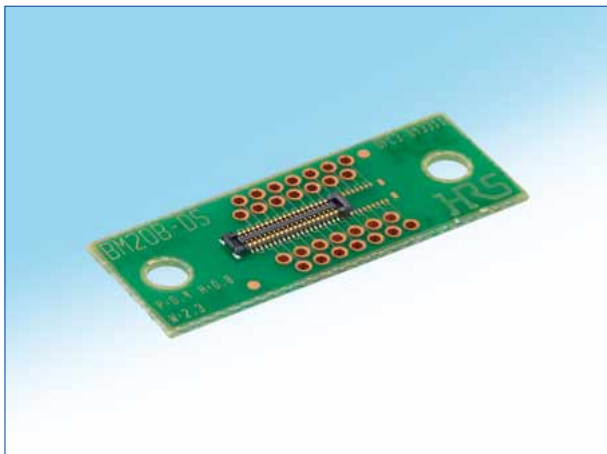

■ H=0.8mm receptacle

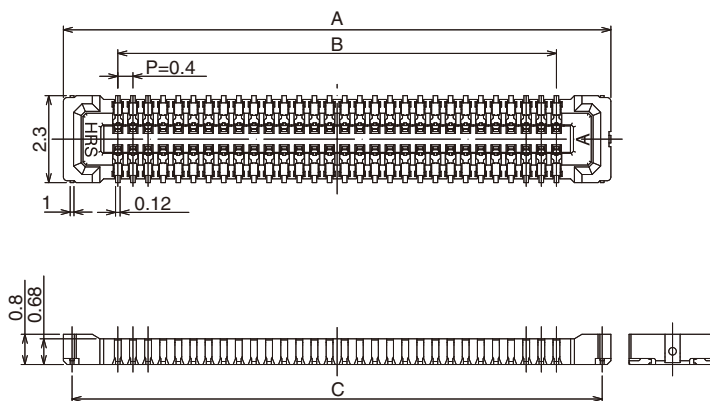
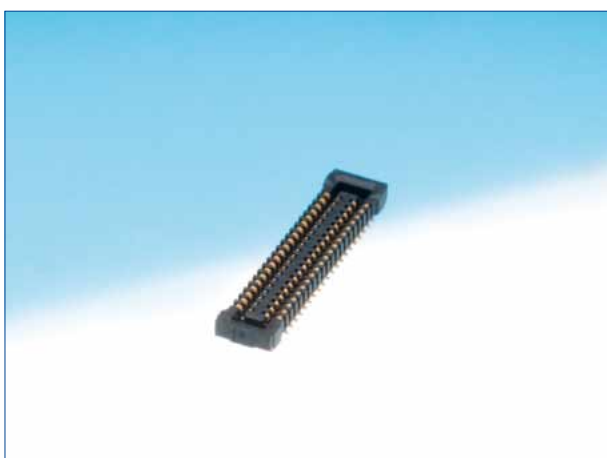

◆ Recommended PCB layout [H= 0.6mm]

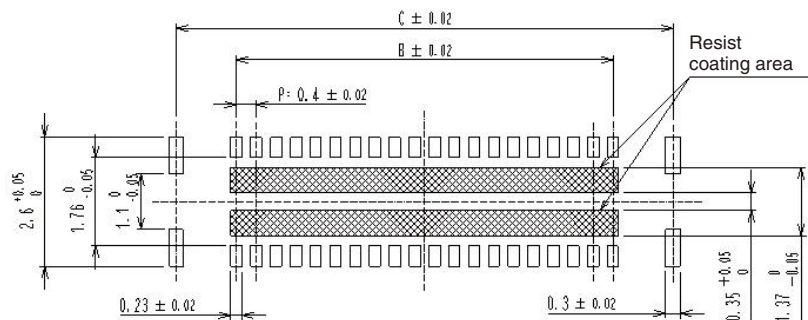

◆ Recommended PCB layout [H= 0.8mm]

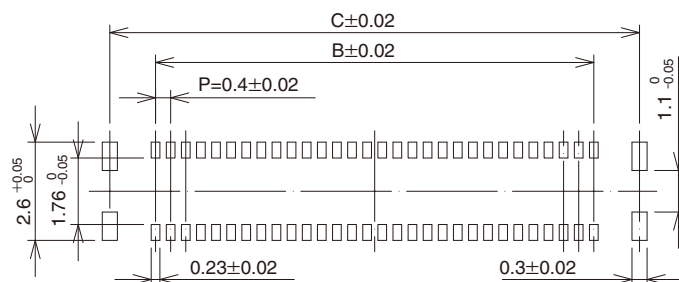

◆Recommended metal mask size (Mask thickness 100 μm) [0.6 mm and 0.8 mm common]

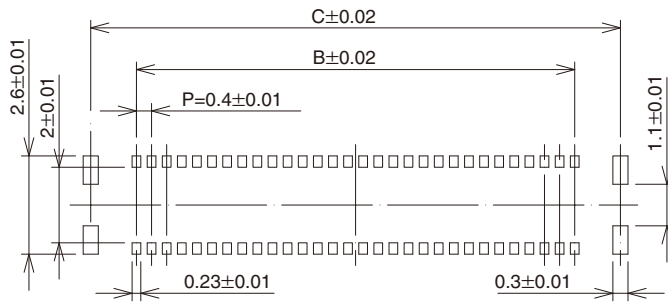

Unit : mm

Part No.	HRS No.	No. of Contacts	A	B	C	D
BM20B(0.6)-10DS-0.4V(51)	0684-9308-8 51	10	4.48	1.6	4.02	4.06
BM20B(0.6)-20DS-0.4V(51)	0684-9309-0 51	20	6.48	3.6	6.02	6.06
BM20B(0.6)-24DS-0.4V(51)	0684-9310-0 51	24	7.28	4.4	6.82	6.86
BM20B(0.6)-30DS-0.4V(51)	0684-9311-2 51	30	8.48	5.6	8.02	8.06
BM20B(0.6)-34DS-0.4V(51)	0684-9312-5 51	34	9.28	6.4	8.82	8.86
BM20B(0.6)-40DS-0.4V(51)	0684-9313-8 51	40	10.48	7.6	10.02	10.06
BM20B(0.6)-50DS-0.4V(51)	0684-9314-0 51	50	12.48	9.6	12.02	12.06
BM20B(0.6)-60DS-0.4V(51)	0684-9315-3 51	60	14.48	11.6	14.02	14.06

Part No.	HRS No.	No. of Contacts	A	B	C
BM20B(0.8)-10DS-0.4V(51)	0684-9008-4 51	10	4.48	1.6	4.02
BM20B(0.8)-16DS-0.4V(51)	0684-9041-0 51	16	5.68	2.8	5.22
BM20B(0.8)-20DS-0.4V(51)	0684-9009-7 51	20	6.48	3.6	6.02
BM20B(0.8)-24DS-0.4V(51)	0684-9010-6 51	24	7.28	4.4	6.82
BM20B(0.8)-30DS-0.4V(51)	0684-9011-9 51	30	8.48	5.6	8.02
BM20B(0.8)-34DS-0.4V(51)	0684-9020-0 51	34	9.28	6.4	8.82
BM20B(0.8)-40DS-0.4V(51)	0684-9012-1 51	40	10.48	7.6	10.02
BM20B(0.8)-50DS-0.4V(51)	0684-9013-4 51	50	12.48	9.6	12.02

Note 1 : This product is sold by full reel quantities of 8,000 pieces per reel. Please place orders in full reel quantities.

Note 2 : This connector is NOT polarized.

[Product Brief]

Ver.1.0

IMX214

Diagonal 5.867mm (Type 1/3.06) 13M Pixel CMOS Image Sensor with Square Pixel for Color Cameras

Description

IMX214 is a diagonal 5.867mm(Type 1/3.06) 13M pixel CMOS active pixel type stacked image sensor with a square pixel array. It adopts Exmor RS™ technology to achieve high speed image capturing by column parallel A/D converter circuits and high sensitivity and low noise image (comparing with conventional CMOS image sensor) through the backside illuminated imaging pixel structure. R, G, and B pigment primary color mosaic filter is employed. By introducing spacially varying exposure technology, high dynamic range still pictures and movies are achievable. It equips an electronic shutter with variable integration time. It operates with three power supply voltages: analog 2.7 V, digital 1.0V and 1.8 V for input/output interface and achieves low power consumption. IMX214 is designed for use in cellular phones or tablet devices*.

Functions and Features

- ◆ Back illuminated and stacked CMOS image sensor Exmor RS
- ◆ Single Frame High Dynamic Range (HDR) with equivalent full pixels.
- ◆ High signal to noise ratio (SNR).
- ◆ Full resolution @30fps (Normal / HDR).4K2K @30fps (Normal / HDR)1080p @60fps (Normal / HDR)
- ◆ Output video format of RAW10/8, COMP8/6
- ◆ Pixel binning readout and H/V sub sampling function
- ◆ Advanced Noise Reduction (Chroma noise reduction and luminance noise reduction)
- ◆ Independent flipping and mirroring.
- ◆ CSI 2 serial data output (MIPI 2lane/4lane, Max. 1.2Gbps/lane, DPHY spec. ver. 1.1 compliant)
- ◆ 2wire serial communication
- ◆ Two PLLs for independent clock generation for pixel control and data output interface.
- ◆ Advanced Noise Reduction.
- ◆ Dynamic Defect Pixel Correction.
- ◆ Zero shutter lag.
- ◆ Power on reset function
- ◆ Dual sensor synchronization operation.
- ◆ 8K bit of OTP ROM for users.
- ◆ Built in temperature sensor

NOTE)

1. When using this product for another application, Sony does not guarantee the quality and reliability of product. Therefore, don't use this for applications other than cellular phone and Tablet PCs. Consult your Sony sales representative if you have any questions.

Device Structure

◆ CMOS image sensor	
◆ Image size	: Diagonal 5.867mm (Type 1/3.06)
◆ Total number of pixels	: 4224 (H) × 3200(V) approx. 13.51M pixels
◆ Number of effective pixels	: 4224 (H) × 3136 (V) approx. 13.25 M pixels
◆ Number of active pixels	: 4208 (H) × 3120 (V) approx. 13.13 M pixels
◆ Chip size	: 6.100mm (H) × 4.524mm (V)
◆ Unit cell size	: 1.12 μm (H) × 1.12 μm (V)
◆ Substrate material	: Silicon

Functional Description

System Outline

IMX214 is a CMOS active pixel type image sensor which adopts the Exmor RS™ technology to achieve high sensitivity, low noise and high speed image capturing. It is embedded with backside illuminated imaging pixel, low noise analog amplifier, column parallel A/D converters which enables high speed capturing, digital amplifier, image binning circuit, timing control circuit for imaging size and frame rate, CSI2 image data high speed serial interface, PLL oscillator, and serial communication interface to control these functions.

Several additional image processing functions and peripheral circuits are also included for easy system optimization by the users. A one time programmable memory is embedded in the chip for storing the user data. It has 8 K-bit for users, 10 K-bit as a whole.

Block Diagram

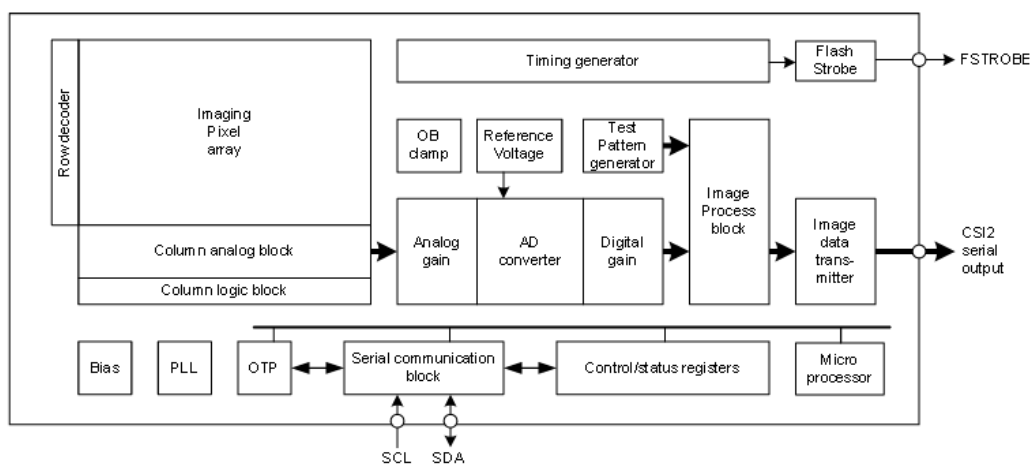

Exmor RS

* Exmor RS is a trademark of Sony Corporation. The Exmor RS is a Sony's CMOS image sensor with high-resolution, high-performance and compact size by replacing a supporting substrate in Exmor R™ which changed fundamental structure of Exmor™ pixel adopted column parallel A/D converter to back-illuminated type, with layered chips formed signal processing circuits.

Sony reserves the right to change products and specifications without prior notice.

This information does not convey any license by any implication or otherwise under any patents or other right.

Application circuits shown, if any, are typical examples illustrating the operation of the devices. Sony cannot assume responsibility for any problems arising out of the use of these circuits.



Kameraanwendungen

your BEST camera module partner



Autopilot



Live-Streaming



Videokonferenz



Biometrische Eye-Tracker-Erkennung



Maschinelles Sehen



Agrarmonitor



Nachtsichtsicherheit



Drohnen- und Sport-Adleraugen



Interaktive Haustierkamera

www.KaiLapTech.com sales@KaiLapTech.com Tel: (852) 6908 1256 Fax: (852) 3017 6778



your BEST camera module partner

Kameraanwendungen



IMAGING DEVICES





Referenztable für die Pinbelegungsdefinition des Kameramoduls

OmniVision Sony Himax Samsung On-Semi Aptina Himax GalaxyCore PixArt Bildsensoren	
Pin Signal	Beschreibung
DGND GND	Masse für digitale Schaltung
AGND	Masse für analoge Schaltung
PCLK DCK	DVP-PCLK-Ausgang
XCLR PWDN XSHUTDOWN STANDBY	Abschalten aktiv hoch mit internem Pulldown-Widerstand
MCLK XVCLK XCLK INCK	Systemeingangsuhr
RESET RST	Aktiv Low mit internem Pull-up-Widerstand zurücksetzen
NC NULL	keine Verbindung
SDA SIO_D SIOD	SCCB-Daten
SCL SIO_C SOIC	SCCB-Eingangstakt
VSYNC XVS FSYNC	DVP-VSYNC-Ausgang
HREF XHS	DVP-HREF-Ausgang
DOVDD	Strom für E/A-Schaltung
AFVDD	Strom für VCM-Schaltung
AVDD	Strom für analoge Schaltung
DVDD	Strom für digitale Schaltung
STROBE FSTROBE	Strobe-Ausgang
FSIN	Synchronisieren Sie das VSYNC-Signal vom anderen Sensor
SID	SCCB letzte Bit-ID-Eingabe
ILPWM	mechanische Shutter-Ausgangsanzeige
FREX	Rahmenbelichtung / mechanischer Verschluss
GPIO	Allzweckeingänge
SLASEL	I2C-Slave-Adresse auswählen
AFEN	CEN-Chip aktivieren aktiv hoch auf VCM-Treiber-IC
MIPI Schnittstelle	
MDN0 DN0 MD0N DATA_N DMO1N	MIPI 1st negative Ausgabe der Datenspur
MDP0 DP0 MD0P DATA_P DMO1P	MIPI 1st positiver Ausgang der Datenspur
MDN1 DN1 MD1N DATA2_N DMO2N	MIPI 2nd negative Ausgabe der Datenspur
MDP1 DP1 MD1P DATA2_P DMO2P	MIPI 2nd positiver Ausgang der Datenspur
MDN2 DN2 MD2N DATA3_N DMO3N	MIPI 3rd negative Ausgabe der Datenspur
MDP2 DP2 MD2P DATA3_P DMO3P	MIPI 3rd positiver Ausgang der Datenspur
MDN3 DN3 MD3N DATA4_N DMO4N	MIPI 4th negative Ausgabe der Datenspur
MDP3 DP3 MD3P DATA4_P DMO4P	MIPI 4th positiver Ausgang der Datenspur
MCN CLKN CLK_N DCKN	MIPI Uhr negativer Ausgang
MCP CLKP MCP CLK_P DCKN	MIPI Takt positiver Ausgang
DVP Parallel Schnittstelle	
D0 DO0 Y0	DVP Datenausgabeport 0
D1 DO1 Y1	DVP Datenausgabeport 1
D2 DO2 Y2	DVP Datenausgabeport 2
D3 DO3 Y3	DVP Datenausgabeport 3
D4 DO4 Y4	DVP Datenausgabeport 4
D5 DO5 Y5	DVP Datenausgabeport 5
D6 DO6 Y6	DVP Datenausgabeport 6
D7 DO7 Y7	DVP Datenausgabeport 7
D8 DO8 Y8	DVP Datenausgabeport 8
D9 DO9 Y9	DVP Datenausgabeport 9
D10 DO10 Y10	DVP Datenausgabeport 10
D11 DO11 Y11	DVP Datenausgabeport 11

Kamera-Zuverlässigkeitstest

Reliability Inspection Item		Testmethode	Akzeptanzkriterium	
Kategorie	Artikel			
Umwelt	Lager Temperatur	Hoch 60°C 96 Std	Temperaturkammer	Keine anormale Situation
		Niedrig -20°C 96 Std	Temperaturkammer	Keine anormale Situation
	Betriebs Temperatur	Hoch 60°C 24 Std	Temperaturkammer	Keine anormale Situation
		Niedrig -20°C 24 Std	Temperaturkammer	Keine anormale Situation
	Feuchtigkeit	60°C 80% 24 Std	Temperaturkammer	Keine anormale Situation
Thermischer Schock	Hoch 60°C 0.5 Std Niedrig -20°C 0.5 Std Radfahren rein 24 Std	Temperaturkammer	Keine anormale Situation	
Physisch	Falltest (Im freien Fall)	Ohne Verpackung 60cm	10 Mal auf Holzboden	Elektrisch funktionsfähig
		Mit Paket 60cm	10 Mal auf Holzboden	Elektrisch funktionsfähig
	Vibrations Test	50Hz X-Axis 2mm 30 Minuten	Vibrationstisch	Elektrisch funktionsfähig
		50Hz Y-Axis 2mm 30 Minuten	Vibrationstisch	Elektrisch funktionsfähig
		50Hz Z-Axis 2mm 30 Minuten	Vibrationstisch	Elektrisch funktionsfähig
Zugfestigkeit des Kabels Krafttest	Gewicht laden 4 kg 60 Sekunden Radfahren rein 24 Std	Zugprüfmaschine	Elektrisch funktionsfähig	
Elektrisch	ESD-Test	Kontaktaufnahme 2 KV	ESD-Prüfmaschine	Elektrisch funktionsfähig
		Luftentladung 4 KV	ESD-Prüfmaschine	Elektrisch funktionsfähig
	Alterungstest	On/Off 30 Sekunden Radfahren rein 24 Std	Stromschalter	Elektrisch funktionsfähig
	USB-Anschluss	On/Off 250 Mal	Einstecken und ausstecken	Elektrisch funktionsfähig





Inspektionsgegenstand		Untersuchungsmethode	Inspektionsstandard	
Kategorie	Artikel			
Aussehen	FPC oder PCB	Farbe	Das bloße Auge	Größere Unterschiede sind nicht zulässig.
		Zerrissen/gehackt werden	Das bloße Auge	Das Freilegen von Kupferrissen ist nicht zulässig.
		Markierung	Das bloße Auge	Klar, erkennbar (innerhalb von 30 cm Entfernung)
	Halterin	Kratzer	Das bloße Auge	Die Freilegung von Rissen im Inneren ist nicht zulässig
		Lücke	Das bloße Auge	Erfüllen Sie den Höhenstandard
		Schraube	Das bloße Auge	Stellen Sie sicher, dass Schrauben vorhanden sind (falls vorhanden)
		Schaden	Das bloße Auge	Die Freilegung von Rissen im Inneren ist nicht zulässig
	Linse	Kratzen	Das bloße Auge	Keine Auswirkung auf den Auflösungsstandard
		Kontamination	Das bloße Auge	Keine Auswirkung auf den Auflösungsstandard
		Ölfilm	Das bloße Auge	Keine Auswirkung auf den Auflösungsstandard
		Abdeckband	Das bloße Auge	Kein Problem beim Aussehen.
	Funktion	Bild	Keine Kommunikation	Testboard
Helles Pixel			Tafel	Im Image Center nicht erlaubt
Dunkles Pixel			Weißer Tafel	Im Image Center nicht erlaubt
Verschwommen			Das bloße Auge	Nicht erlaubt
Kein Bild			Das bloße Auge	Nicht erlaubt
Vertikale Linie			Das bloße Auge	Nicht erlaubt
Horizontale Linie			Das bloße Auge	Nicht erlaubt
Kleines Leck			Das bloße Auge	Nicht erlaubt
Blinkendes Bild			Das bloße Auge	Nicht erlaubt
Prellung			Inspektionslehre	Nicht erlaubt
Auflösung			Diagramm	Folgt dem Diagrammstandard für ausgehende Inspektionen
Farbe			Das bloße Auge	Kein Problem
Lärm			Das bloße Auge	Nicht erlaubt
Ecke dunkel			Das bloße Auge	Weniger als 100 x 100 Pixel
Farbauflösung	Das bloße Auge	Kein Problem		
Abmessungen	Höhe	Das bloße Auge	Follows Approval Data Sheet	
	Breite	Das bloße Auge	Follows Approval Data Sheet	
	Länge	Das bloße Auge	Follows Approval Data Sheet	
	Gesamt	Das bloße Auge	Follows Approval Data Sheet	



KLT-Paketlösungen

KLT Kameramodul



Komplett mit Linsenschutzfolie



Tablett mit Gitter und Raum



Legen Sie die Kameras auf das Tablett



Paketlösung für Kameramodule

Volles Tablett mit Kameras



Abdeckschale mit Deckel



In Antistatikbeutel stecken



Staubsaugen Sie den antistatischen Beutel





Paketlösung für Kameramodule

Versiegelter Vakuumbbeutel mit Etiketten

1. Modell und Beschreibung 2. Menge 3. Versanddatum 4. Achtung





Paketlösung für große Bestellungen

Schaumstoffplatten zwischen
die Tablettts legen



Schaumstoffplatten sind etwas
größer als Tablettts



Legen Sie Schaumstoffplatten und
Tablettts in die Schachtel



Schaumstoffplatten sind eng anliegende Box





Paketlösung für kleine Bestellungen

Legen Sie die Schaumstoffplatten und
Tablets in die kleine Schachtel



Schaumstoffplatten passen gut in
die kleine Box



Paket in kleiner Box für den Versand



Legen Sie kleine Kartons in größere Kartons





Carbon Box Paketlösung

Verschließen Sie die Carbonbox

Beschriftete Schachtel mit Endverpackung



Versandfertige Karbonbox

1. Lieferadresse und Telefonnummer
2. Box-Nr. und Versanddatum
3. Zerbrechliche Vorsicht



Lösung für Musterbestellungspakete

Legen Sie die Probe in einen kleinen antistatischen Beutel



Stecken Sie die Anschlüsse in den kleinen antistatischen Beutel



Musteretiketten auf dem kleinen Beutel

1. Kameramodul oder Anschlussmodell 2. Lieferdatum und Menge 3. Achtung





Connectors Large Order Package Solution

Steckverbinder in einem Rad



Steckverbinder im Rad beschriften



Das Rad passt perfekt in die Box



Steckerbox versandfertig



Unternehmen Kai Lap Technologies (KLT)

Kai Lap Technologies Group Limited. (KLT) wurde 2009 gegründet und ist ein technologiegetriebener Hersteller der nächsten Generation, der sich auf Forschung, Design und Produktion von Audio- und Videoprodukten spezialisiert hat. KLT verfügt über 20.000 Quadratfuß automatisierte Fabriken mit 100 Mitarbeitern und einem jährlichen Durchsatz von 30.000.000 Kameraeinheiten.

KLT bietet OEM-, ODM-Design, Auftragsfertigung und baut die Kameraprodukte. Sie können uns die Anforderungen auch mit einem Handentwurf übermitteln, unser Vertrieb und unsere Technik arbeiten zusammen, um Ihre Anforderungen zu erfüllen. Wir verstehen uns als Ihr langfristiger Partner bei der Entwicklung praktischer und innovativer Lösungen.

Unser Team deckt alles von der ersten Konzeptentwicklung bis zum Massenprodukt ab. KLT ist spezialisiert auf kundenspezifisches Kameradesign, Rohmaterial, Elektrotechnik, Firmware-/Softwareentwicklung, Produkttests und Verpackungsdesign. Unsere erfahrenen strategischen Versorgungssysteme bieten eine robuste und zuverlässige Fertigungskapazität für Aufträge unterschiedlicher Größe.

**Eingeschränkte Garantie**

KLT gewährt die folgende eingeschränkte Garantie, wenn Sie das/die Produkt(e) direkt von der Firma KLT oder von der Website von KLT, www.KaiLapTech.com, gekauft haben. Produkte, die von anderen Verkäufern oder Quellen gekauft wurden, fallen nicht unter diese beschränkte Garantie. KLT garantiert, dass das/die Produkt(e) bei normalem Gebrauch für einen Zeitraum von einem (1) Jahr ab dem Datum, an dem Sie das Produkt erhalten („Garanzzeitraum“), frei von Material- und Verarbeitungsfehlern sind.

Für alle Produkte, die während des Garanzzeitraums Material- oder Verarbeitungsfehler enthalten oder entwickeln, wird KLT nach eigenem Ermessen entweder: (i) die Produkte reparieren; (ii) das/die Produkt(e) durch ein neues oder generalüberholtes Produkt(e) ersetzen (Ersatzprodukt(e) sind von identischem Modell oder funktionell gleichwertig); oder (iii) Ihnen den Preis erstatten, den Sie für das/die Produkt(e) gezahlt haben.

Diese eingeschränkte Garantie von KLT ist ausschließlich auf Reparatur und/oder Ersatz zu den oben genannten Bedingungen beschränkt. KLT ist nicht zuverlässig oder verantwortlich für nachfolgende Ereignisse.





CMOS CAMERA MODULES



your BEST camera module partner

KLT Stärke

Leistungsstarke Fabrik



Professioneller Service



Versprochene Lieferung



www.KaiLapTech.com sales@KaiLapTech.com Tel: (852) 6908 1256 Fax: (852) 3017 6778

All rights reserved @ Kai Lap Technologies Group Ltd. Specifications subject to change without notice.